

xylem
Let's Solve Water



HotShot™ Series

MARINE WASHDOWN PUMPS



a xylem brand

HotShot™ Series MARINE WASHDOWN PUMPS

Years of clean decks and satisfaction in the form of robust and reliable high-flow and high-pressure diaphragm pumps.

The Jabsco legacy of exceptional products continues with this updated and improved lineup of washdown pumps and kits.

HD (Heavy Duty) models include a wider diameter motor with a powder coated shell, cast aluminum endbells and lower housing to improve pressure capability and life.

Standard models provide exceptional performance in an economical footprint. A plastic housing protects the motors from corrosion.

Features and Benefits:

- Co-molded diaphragm technology for long life and durability
- HD models feature heavy duty, motors and cast aluminum lower housings which allow for long-life, even at high pressures
- Efficient and quiet operation
- Integrated, sealed pressure switch for on-demand operation
- Self-priming allows for installation versatility
- Can run dry without damage
- Quick connect ports for ease of installation, servicing, and maintenance
- Vibration dampening mounting feet
- Full kit versions available which include 25' (7.6m) hose coil

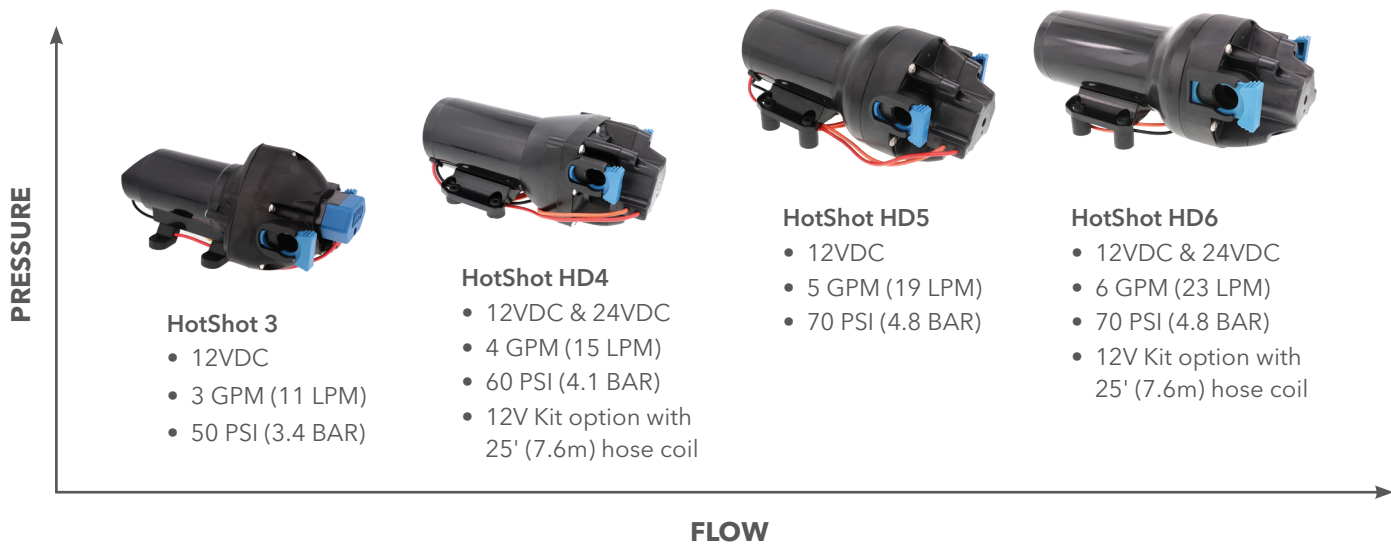

Configurations & Part Numbers:

Model Line	Model #	Voltage VDC	Open Flow GPM (LPM)	Shut-off Pressure PSI (BAR)	Max Current AMPS	Recommended Fuse Size	Port Fittings	Strainer Included	Trigger Nozzle	Hose
HotShot 3	32305-5012-3A	12	3 (11)	50 (3.4)	7.5	15	2 x 1/2" Straight Hosebarb	Inline	Standard	No
HotShot HD4	Q401J-118N-3A	12	4 (15)	60 (4.1)	11.0	20		90°	Standard	No
HotShot HD4	Q401J-118N-4A	12	4 (15)	60 (4.1)	11.0	20	2 x 3/4" Straight Hosebarb	90°	Standard	25' Coil
HotShot HD4	Q402J-118N-3A	24	4 (15)	60 (4.1)	6.0	10		90°	Standard	No
HotShot HD5	P501J-119N-3A	12	5 (19)	70 (4.8)	16.0	25	1 x 3/4" GHT Adapter	90°	Standard	No
HotShot HD6	P601J-219N-3A	12	6 (23)	70 (4.8)	19.0	25		90°	Deluxe	No
HotShot HD6	P601J-219N-4A	12	6 (23)	70 (4.8)	19.0	25	2 x 3/4" Straight Hosebarb	90°	Deluxe	25' Coil
HotShot HD6	P602J-219N-3A	24	6 (23)	70 (4.8)	9.4	15		90°	Deluxe	No

HotShot™ Series MARINE WASHDOWN PUMPS

Typical Installation:

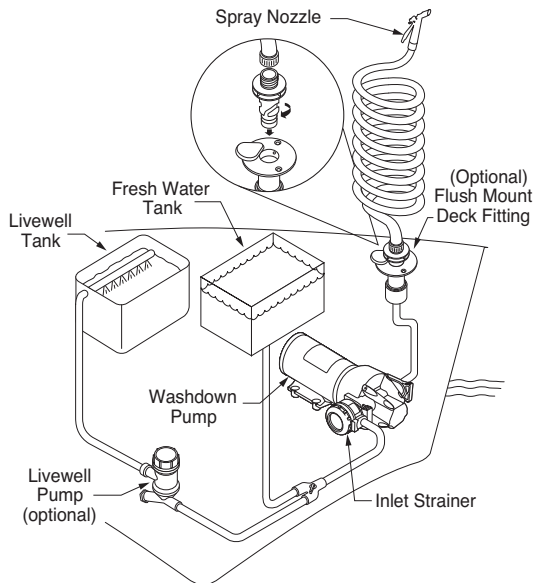

Specifications:

Motor design	Brushed, permanent magnet TENV
Pumphead upper housing material	Glass fiber reinforced polypropylene
Diaphragm	Co-molded TPV
Check valves	EPDM
Max inlet pressure	30 PSI (2.1 Bar)
Fluid temperature range	32°F - 140°F (0°C - 60°C)
Dry self-priming capability	7ft min (2.1m min)
Certifications	CE, ISO8846, RCM
Ingress protection	IPX6
Voltage, flow, pressure, port fittings, etc.	Refer to PN table
Other info	Refer to data-sheet. These can be found on website.

Major Dimensions:

(Hotshot HD4 shown)

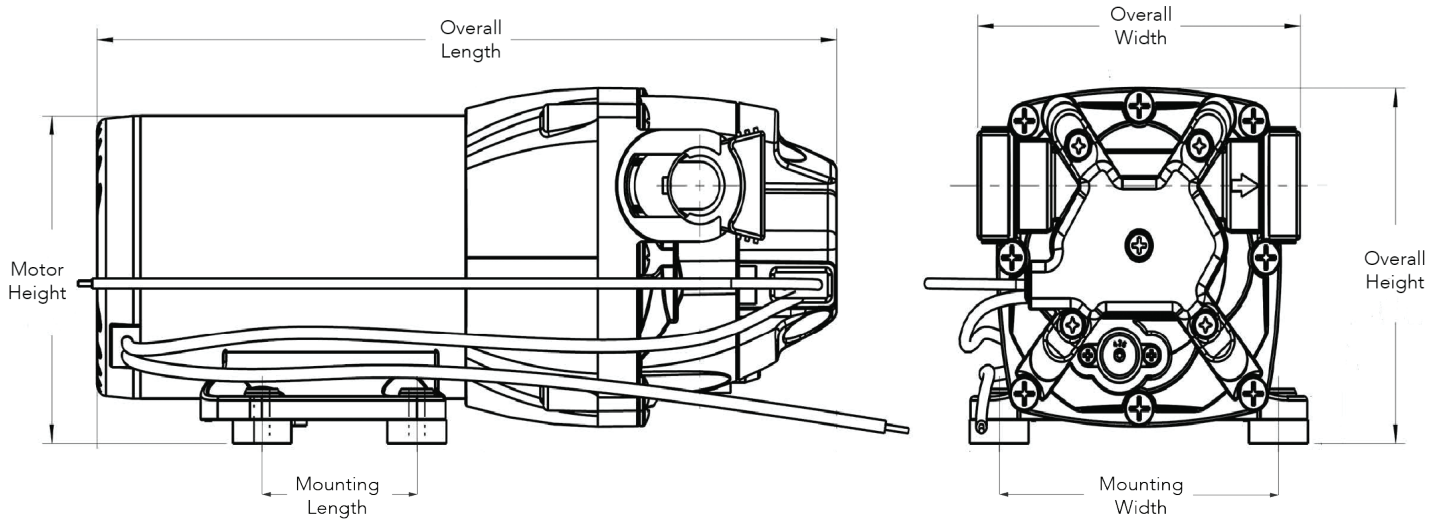





Model	Overall Length in. (mm)	Overall Width in. (mm)	Overall Height in. (mm)	Motor Height in. (mm)	Mounting Length (ctr to ctr*) in. (mm)	Mounting Width (ctr to ctr*) in. (mm)
HotShot 3	9.1 (231)	4.2 (107)	4.2 (107)	3.1 (79)	2.3 (58)	3.2 (81)
HotShot HD4	9.4 (239)	4.1 (104)	3.8 (97)	3.5 (89)	2.0 (51)	3.6 (91)
HotShot HD5	9.6 (244)	5.0 (127)	4.7 (119)	4.0 (102)	2.0 (51)	3.6 (91)
HotShot HD6	10.2 (259)	5.1 (129)	4.7 (119)	4.0 (102)	2.0 (51)	3.6 (91)

*ctr = center of mounting hole

HotShot™ Series MARINE WASHDOWN PUMPS

Fittings & Accessories:

Pump	Fittings	Strainer	Nozzle	Hose
 <p>HotShot 3</p>	 <p>Quick Connect straight hosebarb and GHT fittings. Size varies by model.</p>	 <p>Inline 40 mesh Quick Connect strainer</p>	 <p>Trigger nozzle & Quick Connect hose adapters</p>	<p>No kit versions with hose offered</p>
 <p>HotShot HD4</p>	 <p>Quick Connect straight hosebarb and GHT fittings. Size varies by model.</p>	 <p>90° 20 mesh Quick Connect strainer</p>	 <p>Trigger nozzle & Quick Connect hose adapters</p>	 <p>Kit version includes 25' hose coil</p>
 <p>HotShot HD5</p>	 <p>Quick Connect straight hosebarb and GHT fittings. Size varies by model.</p>	 <p>90° 20 mesh Quick Connect strainer</p>	 <p>Trigger nozzle & Quick Connect hose adapters</p>	<p>No kit versions with hose offered</p>
 <p>HotShot HD6</p>	 <p>Quick Connect straight hosebarb and GHT fittings. Size varies by model.</p>	 <p>90° 20 mesh Quick Connect strainer</p>	 <p>Trigger nozzle & Quick Connect hose adapters</p>	 <p>Kit version includes 25' deluxe hose coil</p>

Other Available Fittings & Accessories

See website for part numbers and details



Quick Release deck mount fitting

Allows easy disconnect and stowage of deck washdown hoses



Port fittings

Options include threaded, 90°, and more



Warranty: All products of the company are sold, and all services of the company are offered subject to the company's warranty and terms of sale, copies of which will be furnished upon request. The information provided herein is for guidance only, it does not constitute a guarantee of the performance or specification of any individual product or component.

www.xylem.com/jabsco

USA

Xylem Inc.
100 Cummings Center Dr.
Suite 535-N
Beverly MA, 01915
Tel: +1 978 281 0440
Fax: +1 978 283 2619

USA

Xylem Inc.
17942 Cowan
Irvine, CA 92614
Tel: +1 949 608 3900
Fax: +1 949 608 3887

UK

Xylem Inc.
Bingley Road, Hoddesdon
Hertfordshire EN11 0BU
Tel: +44 (0) 1992 450145
Fax: +44 (0) 1992 467132

CHINA

Xylem Inc.
30/F Tower A
100 Zunyi Road
Shanghai, China 200051
Tel: +86 21 2208 2888
Fax: +86 21 2208 2999

GERMANY

Xylem Inc.
Oststrasse 28
22844 Norderstedt
Tel: +49 40 53 53 73 0
Fax: +49 40 53 53 73 11

ITALY

Xylem Inc.
Via Tommaseo, 6
20059 Vimercate, Milano
Tel: +39 039 685 2323
Fax: +39 039 666 307

AUSTRALIA

Xylem Inc.
3/1 Federation Way
Moorabbin Airport, VIC 3194
Tel: +61 3 8551 6800
Fax: +61 2 9832 6493